

ASSEMBLY INSTRUCTIONS

Complementary Support

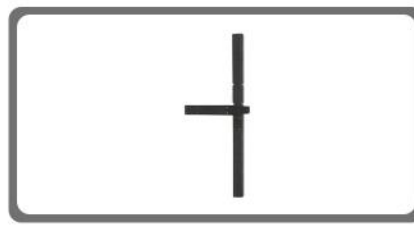

PIECES

1 x



Column 3.5" x 3.5"

1 x



Column 3.5" x 3.5"

16 x



Hollow Base

2 x



Washer 5/16"

2 x



T-Joint

2 x



Screw FL 6x60mm

1 x



Column Cover 3.5" x 3.5"

STEP BY STEP

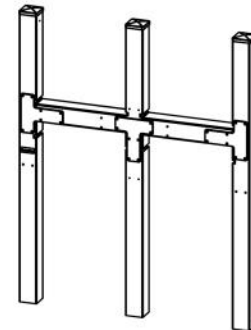
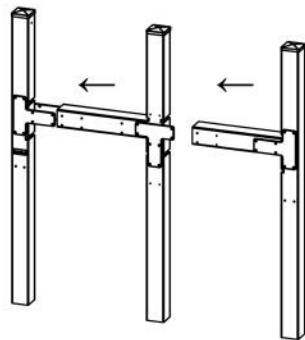
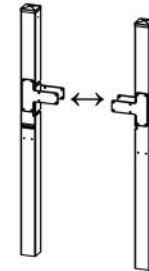
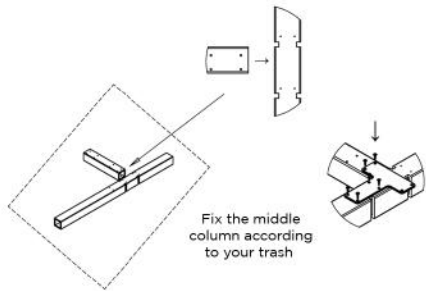

▼ END

Contact us:

For US Corporation:

www.foruseco.com

1-561-774 0707

In Brasil:

www.inbrasil.ind.br

+55 042 3135-5000



INSTRUCCIONES DE ENSAMBLE

Apoyo Complementario



In Brasil



MANUAL DE MONTAGEM

Suporte complementar



In Brasil



PIEZAS

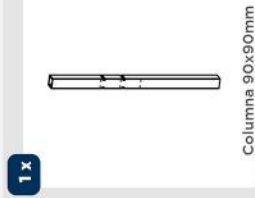

1 x

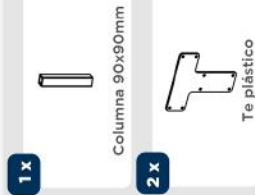

1 x

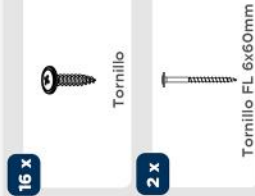

16 x



2 x



1 x

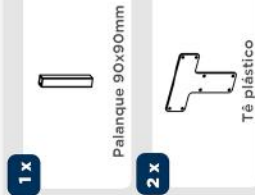

2 x

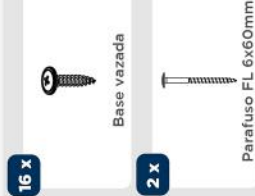

16 x



2 x



1 x

PIEZAS

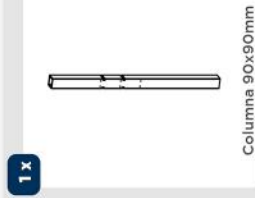

1 x

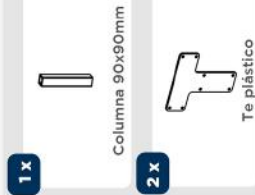

1 x

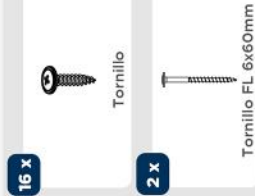

16 x



2 x

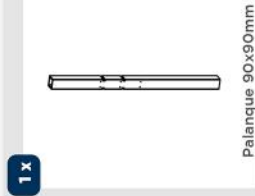

1 x

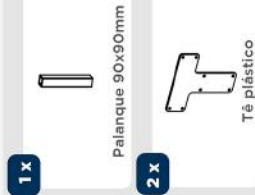

2 x

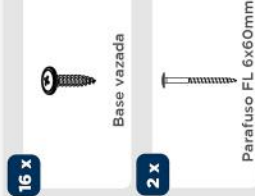

16 x



2 x



1 x

PIEZAS

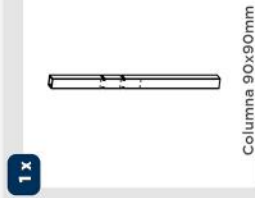

1 x

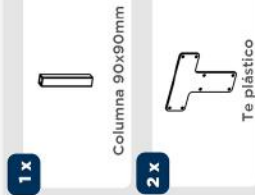

1 x

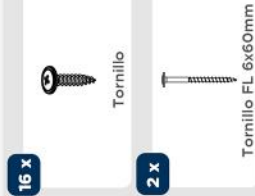

16 x



2 x

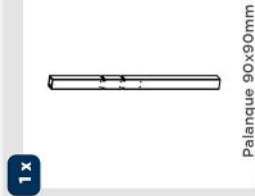

1 x

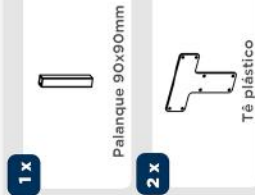

2 x

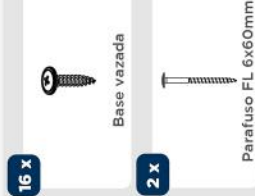

16 x



2 x



1 x

PIEZAS

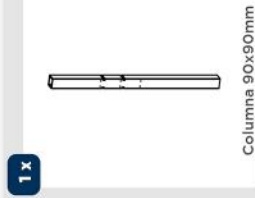

1 x

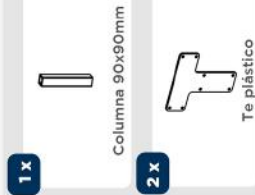

1 x

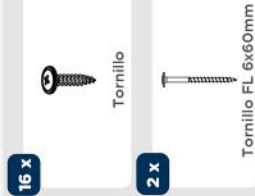

16 x



2 x



1 x

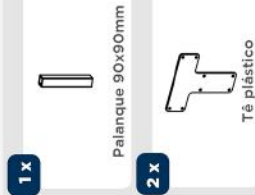

2 x

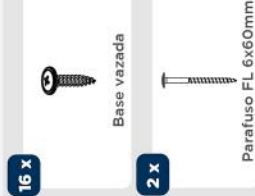

16 x



2 x



1 x

PASO A PASO

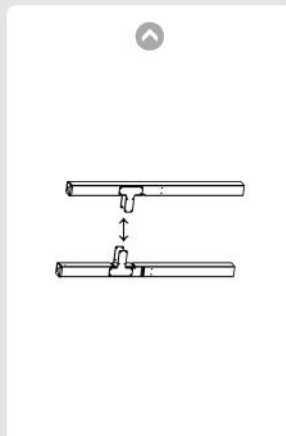
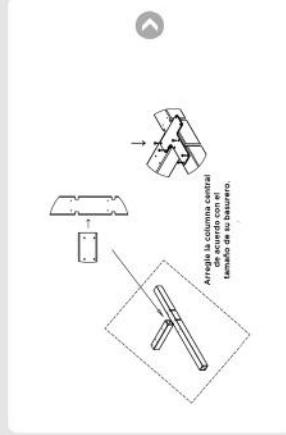

PASO A PASO

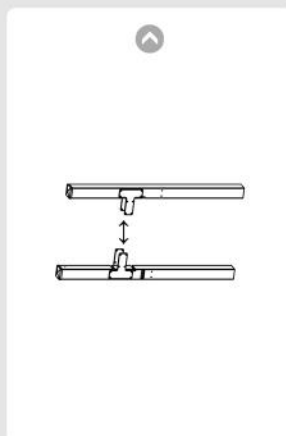
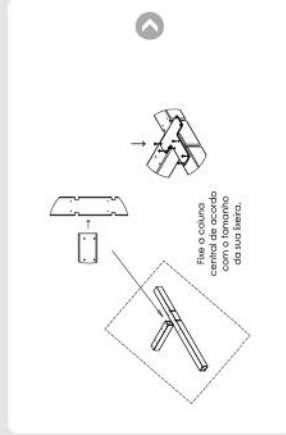

PASO A PASO

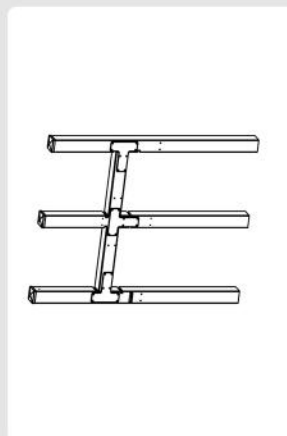
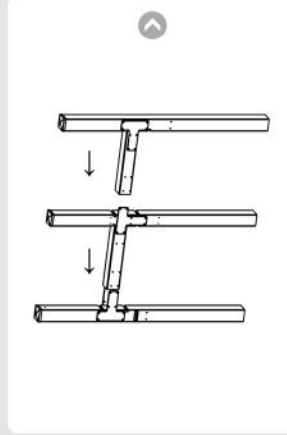

PASO A PASO

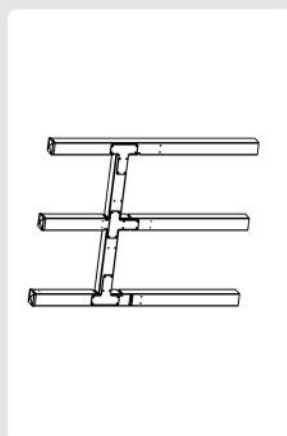
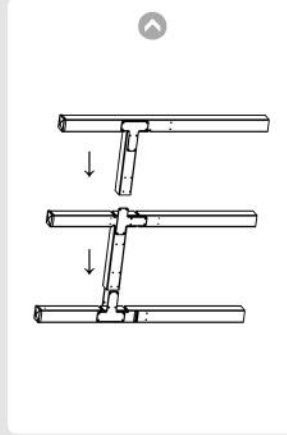

Contáctenos:

For US Corporation:

www.foruseco.com

1-561-774 0707

In Brasil:

www.inbrasil.ind.br

+55 042 3135-5000



FIN



FIN

